

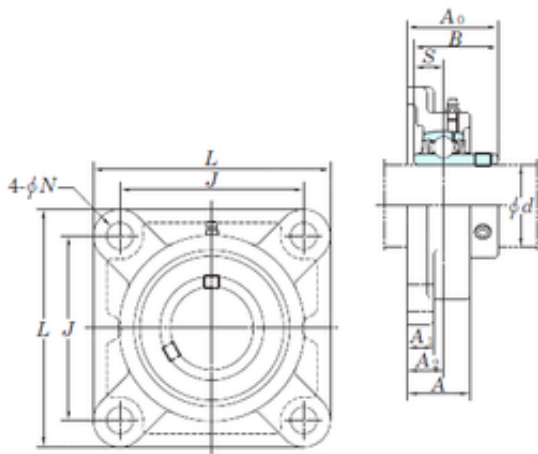

KOYO UCF320 bearing units



Bearing No. UCF320

Bore Diameter	100 mm
d	100 mm
A0	125 mm
A	94 mm
A1	32 mm
B	108 mm
J	242 mm
L	310 mm
N	38 mm
S	42 mm
Bolt (G)	M33
A2	59 mm
Weight	25,8 Kg
Basic dynamic load rating (C)	173 kN
Basic static load rating (C0)	141 kN
Bearing No.	UCF320
Bolt size	M33
Cr	173
C0r	141
f0	13.2
(Refer.)Unit mass(kg)	25.8
Nipple size	R1/8

UCF320 Bearing 2D drawings and 3D CAD models